

KEY TELEPHONE USER GUIDE

Panasonic®



ICX
Integrated Communication eXchange

Before using this phone, please
read these instructions completely.

Section 750
Issued August, 1998

The contents of this manual are subject to change without notice and do not constitute a commitment on the part of Matsushita Communication Industrial Co. Ltd (MCI). Every effort has been made to ensure the accuracy of this document. However, due to ongoing product improvements and revisions, Panasonic cannot guarantee the accuracy of printed material after the date of publication, nor can it accept responsibility for errors or omissions. Panasonic will update and revise this document as needed.

The software and hardware described in this document may be used or copied only in accordance with the terms of the license pertaining to the said software or hardware.

Reproduction, publication, or duplication of this manual, or any part thereof, in any manner, mechanically, electronically, or photographically, is prohibited without permission of the Matsushita Communication Industrial Co. Ltd (MCI).

©Copyright 1998 by Matsushita Communication Industrial Co. Ltd (MCI)

All rights reserved.

Contents

Preface 5

1. Understanding Your Phone 7

Non-Display Phones 7

Small-Display Phones 9

 Changing the Default Display 11

 Understanding Display Information 11

 Using Variable Mode 12

Large-Display Phones 13

 Changing the Default Display 15

 Understanding Display Information 16

2. Setting Up Your Phone 18

Adjusting Volume and Display Settings 18

Setting Up Flexible Function Keys 19

Setting Up One-touch Keys 20

Setting Up Speed Dialling 22

 Assigning and Deleting PSD Numbers 22

 Assigning SSD Numbers 25

 Linking System Speed Dial Numbers 25

 Assigning and Deleting Names for PSD Numbers 26

3. Placing Outside Calls 31

Accessing an Outside Line 31

Using Account Codes 32

 Non-verified Account Codes 32

 Verified Account Codes 33

Redialing Outside Numbers 33

Using Speed Dialling 34

 Dialling Speed Dial Numbers 34

 Checking Speed Dial Numbers 36

4. Handling Incoming Calls 38

Answering Calls 38

Using Call Hold 38

Transferring Calls 40

 Supervised Transfers 40

Unsupervised Transfers 40

Call Pickup 41

 Extension Group Pickup 41

 Extension Direct Pickup..... 42

 Trunk Group Pickup..... 43

 Trunk Direct Pickup..... 43

Call Park 44

5. Communicating Within Your Office 45

Calling Other Extensions 45

 45

 Switching Between Tone and Voice Calling 46

Using Paging 47

 Answering a Page (Meet-Me Answer)..... 47

Making Announcements to Busy Extensions 48

 Answering an Announcement 48

 Transferring Calls with an Announcement 48

Using Call Forwarding..... 49

Using Camp-on (Call Waiting) 51

Using Message Waiting/Callback 52

Using Do-Not-Disturb..... 53

6. Using Additional Features..... 55

Using the MIC Key 55

Using Off-Hook Monitor 56

Using Handsfree Answerback and Operation 56

Using Voice Recognition..... 56

Using the Flash Feature 57

Making Conference Calls..... 57

Controlling Background Music..... 58

Using Timed Reminders..... 58

Using Caller ID 59

 Caller ID Call Log 59

 Call Log Operation for a Small-display Phones 60

 Call Log Format for the Large-Display Phone 61

Walking Class of Service 62

Appendix A. Dial Code List 63

Appendix B. Customized PSD Bin Numbers 66

PREFACE

The *Key Telephone User Guide* is for anyone who uses a Panasonic digital telephone in conjunction with the Panasonic ICX. The ICX is a telephone system that provides you with a powerful set of features for handling calls.

This manual provides an overview of the following digital phones and offers detailed information about using the features provided by the ICX:

:

	U.K.	Hong Kong
• 12 key-Standard	VB-D411UK	_____
• 12 key-Speakerphone	_____	VB-44221HK
• 12 key-Display Speakerphone	VB-D411DSUK	VB-44223HK
• 12 key-Large Display Speakerphone	VB-D411LDSUK	VB-44225HK
• 12 key-Soft key Display Speakerphone	VB-D411DSVUK	VB-44224HK
• 24 key-Display	VB-D611DUK	_____
• 24 key-Display Speakerphone	VB-D611DSUK	VB-44233HK
• EM24-24 key Expansion Module	VB-D331UK	VB-44310HK
• DSS-72 key DSS/BLF	VB-D631UK	VB-44320HK

HOW TO USE THIS MANUAL

We recommend that you read the entire manual before using your digital phone, in order to get a clear idea of its capabilities.

WHAT THIS MANUAL CONTAINS

This manual contains the following chapters:

- Chapter 1, “Understanding Your Phone” - Describes features of Panasonic digital telephones.
- Chapter 2, “Setting Up Your Phone” - Provides procedures for setting up telephone features such as Flexible Function (FF) keys.

- Chapter 3, “Placing Outside Calls” - Provides procedures for making outside calls.
- Chapter 4, “Handling Incoming Calls” - Provides several procedures for answering calls.
- Chapter 5, “Communicating Within Your Office” - Provides procedures for handling internal calls.
- Chapter 6, “Using Additional Features” - Provides procedures for using additional features.
- Appendix A, “Dial Code List.” - Provides a list of dial codes used for programming FF keys.
- Appendix B, “Customized PSD Bin Numbers.” - Provides a table for documenting or tracking your personalized list of speed dial numbers.

NOTATION USED

This user guide uses the following conventions:

- References to chapters and sections are enclosed in quotation marks and include the title and page number. For example: “Setting Up Flexible Function Keys” on page 19.
- References to information you are to enter or dial are printed in boldface, mixed-case characters. For example: Enter **73***.
- References to the telephone keypad are printed in bold, upper case characters. For example: Press the **HOLD** key.

FOR MORE INFORMATION

For more information about features available with the Panasonic ICX system and digital phones, contact your system administrator or ICX dealer, or refer to the Panasonic publication *Feature Operation (Section 700)*.

1. UNDERSTANDING YOUR PHONE

The following information in this chapter will familiarize you with your Panasonic digital phone and enable you to effectively use its call-handling features:

- Non-Display Phones (page 7)
- Small-Display Phones (page 9)
- Large-Display Phones (page 13)
- Using Variable Mode (page 12)
- Changing the Default Display (pages 11 and 15)
- Understanding Display Information (pages 11 and 16)

NON-DISPLAY PHONES

Non-display phones do not have a Liquid Crystal Display (LCD). Table 1 on page 8 describes the features (1-18 below) that are typical of non-display phones.

Figure 1. Non-display phone

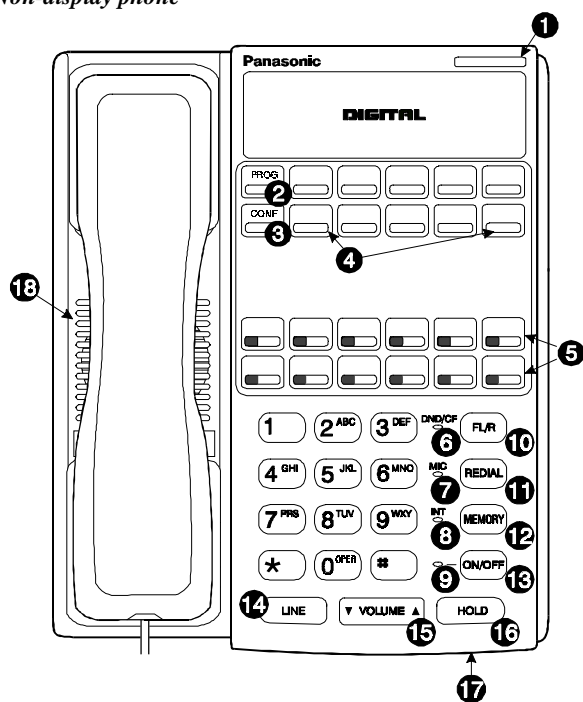

Table 1. Non-display phone features

#	Feature	Description
1	Message Waiting Indicator	Indicates that you have a message.
2	PROG Key	Used to program Flexible Function (FF) and one-touch keys, to adjust ringer volume, and to send a flash signal. Depending on the setup of your system, may also be used to transfer calls.
3	CONF Key	Used to establish conference calls and to check FF key and one-touch features.
4	One-Touch Keys	Used to make outside calls or to access system features.
5	Flexible Function (FF) Keys	Used to access outside lines or to access system features.
6	DND/CF Indicator	Indicates that Do-Not-Disturb (DND) or Call Forwarding is set.
7	MIC Indicator	Indicates that your voice is not muted (i.e., party on the other end can hear you). Goes off when your hands-free microphone is muted and flashes when your handset is muted.
8	INT Indicator	Lights when you are on a call and flashes when you hold a call.
9	ON/OFF Indicator	Lights when the ON/OFF key has been pressed.
10	FL/R Key	Used to end an outside call and to either restore outside dial tone or switch to external dial tone status without hanging up the receiver.
11	REDIAL Key	Used to redial the last number dialed.
12	MEMORY Key	Used to access speed dialling or enter account codes.
13	ON/OFF Key	Used to make a call without lifting the handset or to turn the speaker on and off.
14	LINE Key	Used to seize a free outside line.
15	VOLUME Key	Used to adjust the level of tones, background music, ringing, receiver volume, and display contrast.
16	HOLD Key	Used to hold calls, to retrieve held calls, and to complete FF key programming.
17	Microphone	Used to talk to another party without using the handset.
18	Speaker	Outputs tones and voice at your extension.

SMALL-DISPLAY PHONES

Small-display phones have a display containing two lines of text. Table 2 on page 9 describes the features (1-22 below) that are typical of small-display phones.

Figure 2. Small-display phone

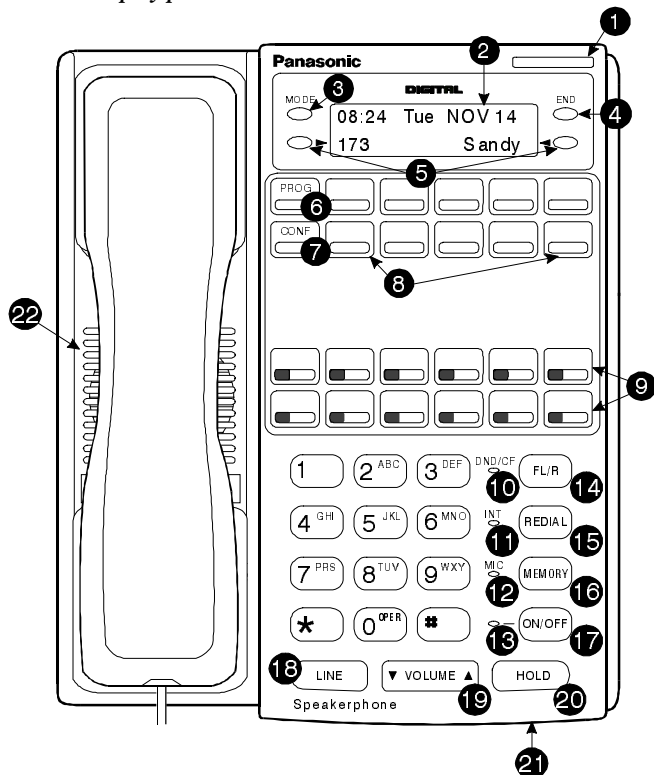

Table 2. Small-display phone features

#	Feature	Description
1	Message Waiting Indicator	Indicates that you have a message.
2	Display	Displays information about the phone's status, menus, and dialling directories, .
3	MODE Key	Used to change display modes from Default Mode to Speed Dial Mode or Extension Directory Mode.
4	END Key	Used to exit Directory Mode and return the display to Default Mode.

#	Feature	Description
5	Soft Keys	Used to select speed dial directories or numbers.
6	PROG Key	Used to program Flexible Function (FF) and one-touch keys, to adjust ringer volume, and to send a flash signal. Depending on the setup of your system, may also be used to transfer calls.
7	CONF Key	Used to establish conference calls and to check FF key and one-touch features.
8	One-Touch Keys	Used to make outside calls or to access system features.
9	Flexible Function (FF) Keys	Used to access outside lines or to access system features.
10	DND/CF Indicator	Indicates that Do-Not-Disturb (DND) or Call Forwarding is set.
11	INT Indicator	Lights when you are on a call and flashes when you hold a call.
12	MIC Indicator	Indicates that your voice is not muted (i.e., party on the other end can hear you). Goes off when your hands-free microphone is muted and flashes when your handset is muted.
13	ON/OFF Indicator	Lights when the ON/OFF key has been pressed.
14	FL/R Key	Used to end an outside call and to either restore outside dial tone or switch to external dial tone status without hanging up the receiver.
15	REDIAL Key	Used to redial the last number dialed.
16	MEMORY Key	Used to access speed dialling or enter account codes.
17	ON/OFF Key	Used to make a call without lifting the handset or to turn the speaker on and off.
18	LINE Key	Used to seize a free outside line.
19	VOLUME Key	Used to adjust the level of tones, background music, ringing, receiver volume, and display contrast.
20	HOLD Key	Used to hold calls, to retrieve held calls, and to complete FF key programming.
21	Microphone	Used to talk to another party without using the handset.
22	Speaker	Outputs tones and voice at your extension.

Changing the Default Display

The **MODE** key enables you to change the software mode of the display from Default Mode (i.e., time and date) to Directory Mode (i.e., System Speed Dial [SSD], Personal Speed Dial [PSD], or Extension directories). The **END** key enables you to return the display to Default Mode.

While in Directory Mode, the soft keys enable you to view either the SSD, PSD, or Extension directories. After selecting the desired directory, the soft keys also enable you to either view or dial speed dial or extension numbers. (For more information on using directories to make calls, see “Dialling Speed Dial Numbers” on page 34 and “Calling Other Extensions” on page 45.)

While in Variable Mode, you can also use the soft keys to access various system features.

Notes:

- You must be in Directory Mode to view speed dial and extension directories or dial speed dial numbers using the soft keys.
- The system features displayed in Variable Mode require system programming

▶ To display the Directory Mode on a small-display phone

1. (A) Press the **MODE** key one time to access the speed dial directories. (**SSD** and **PSD** appear on the second line of the display.)

OR

- (B) Press the **MODE** key twice to access the Extension Directory. (**EXT** appears on the second line of the display.)

2. Press the **END** key to return to Default Mode.

Understanding Display Information

Display information indicates the status of the phone. However, this information will vary depending on how the phone is programmed and its status. Several of the more common displays are illustrated below.

Figure 3. Idle condition for small-display phone (display default)

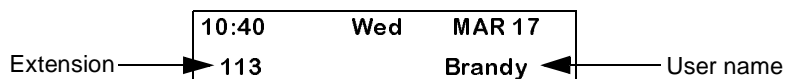

Figure 4. Messages received for small-display phone

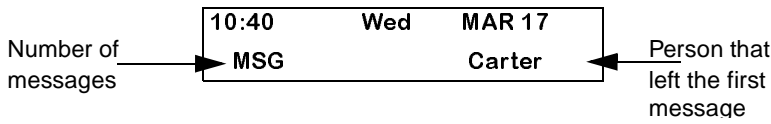

Figure 5. Reminder alarm for small-display phone

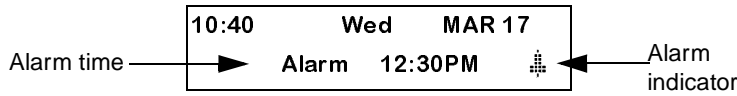

Figure 6. Incoming outside call for small-display phone



Figure 7. Outside call in progress for small-display phone



Figure 8. Internal calling in use for small-display phone

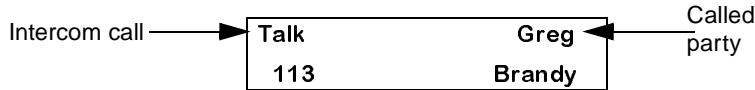

Using Variable Mode

Using Variable Mode allows you to use the soft keys to access programmed system features when your phone is in the following states:

- During an intercom call
- During a CO dial tone
- During a trunk call
- After dialling a busy extension

► To activate Variable Mode on a small-display phone

1. Lift the handset or press the **ON/OFF** key.

2. Press Variable Mode Key.
3. Replace the handset or press the **ON/OFF** key.

▶ To use Variable Mode on a small-display phone

1. After turning Variable Mode on, the display will reflect the programmed features during an intercom call, CO dial tone, trunk call, or after dialling a busy extension.
2. Press the > or < key next to the desired feature.

LARGE-DISPLAY PHONES

Large-display phones are distinguished by their large displays. Table 3 on page 14 describes the features (1-23 below) that are typical of large display phones.

Figure 9. Large-display phone

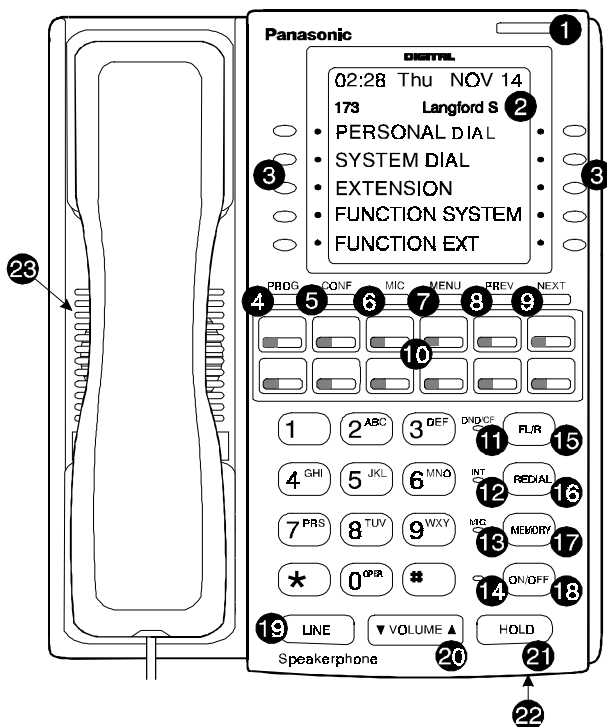

Table 3. Large-display phone features

#	Feature	Description
1	Message Waiting Indicator	Indicates that you have a message.
2	Display	Displays information about the phone's status, menus, and dialling directories.
3	Soft Keys	Used to select menus, directories, speed dial numbers, and to access call-handling features.
4	PROG Key	Used to program FF and one-touch keys, to adjust ringer volume and to send a flash signal. Depending on the setup of your system, may also be used to transfer calls.
5	CONF Key	Used to establish conference calls and to check Flexible Function (FF) and one-touch key settings.
6	MIC Key	Used to activate/deactivate the Microphone/Mute function. When activated, the party on the other end can hear you. (See item 13, MIC Indicator.)
7	MENU Key	Used to return to the default Main Menu screen which contains the following items: <ul style="list-style-type: none"> • Personal Dial • System Dial • Extension • Function System • Function Ext
8	PREV Key	Used to return to the previous screen.
9	NEXT Key	Used to advance to the next screen.
10	Flexible Function (FF) Keys	Used to access outside lines or to access system features.
11	DND/CF Indicator	Indicates that Do-Not-Disturb (DND) or Call Forwarding is set.
12	INT Indicator	Lights when you are on a call and flashes when you hold a call.
13	MIC Indicator	Indicates that your voice is not muted (i.e., party on the other end can hear you). Goes off when your hands-free microphone is muted and flashes when your handset is muted.
14	ON/OFF Indicator	Lights when the ON/OFF key has been pressed.
15	FL/R Key	Used to end an outside call and to either restore outside dial tone or switch to external dial tone status without hanging up the receiver.
16	REDIAL Key	Used to redial the last number dialled.

#	Feature	Description
17	MEMORY Key	Used to access speed dialling or enter account codes.
18	ON/OFF Key	Used to make a call without lifting the handset or to turn the speaker on and off.
19	LINE Key	Used to seize a free outside line.
20	VOLUME Key	Used to adjust level of tones, background music, ringing, receiver volume, and display contrast.
21	HOLD Key	Used to hold calls, to retrieve held calls, and to complete FF key programming.
22	Microphone	Used to talk to another party without using the handset.
23	Speaker	Outputs tones and voice at your extension.

Changing the Default Display

The ten soft keys located alongside the display on a large-display phone allow you to change the software mode of the display. Instead of displaying the Main Menu (Default Mode) for instance, you can set your phone to display one of the following directories or menus:

- Personal Dial - Allows you to program, view, or dial PSD numbers using the soft keys.
- System Dial - Allows you to view or dial SSD numbers using the soft keys.
- Extension - Allows you to view or dial other extensions using the soft keys.
- Function System - Allows you to access most key telephone features, such as Call Forwarding, Do-Not-Disturb (DND), Microphone Mute, Background Music, Call Pickup, Account Codes, etc.
- Function Extension - Allows you to assign frequently used phone features for easy access. Most items found under the Function System Menu can be assigned to the Function Extension Menu in any order you desire.

► To display a directory or menu on a large-display phone

1. Press the soft key to the left of the desired directory or menu. (The selected directory or menu of feature displays.)
2. Press the **MENU** key to return to the Main Menu.

Note: Menus are programmable or customizable per extension. Therefore, the actual menu that displays depends on your system configuration.

Understanding Display Information

Display information indicates the status of the phone. However, this information will vary depending on how the phone is programmed and its status. Several of the more common displays are illustrated below.

Figure 10. Idle condition for large-display phone (display default)

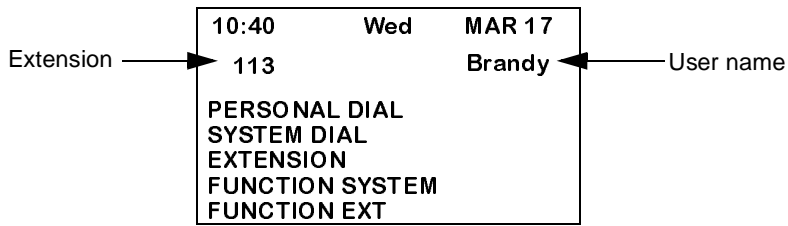

Figure 11. Messages received for large-display phone

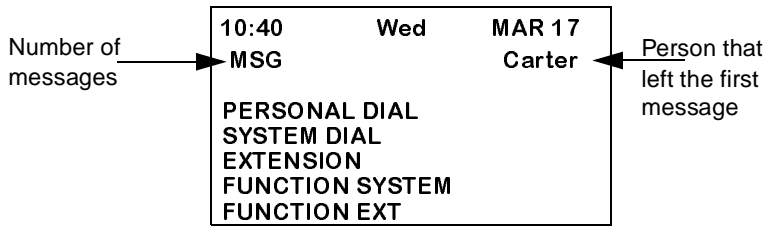

Figure 12. Reminder alarm for large-display phone

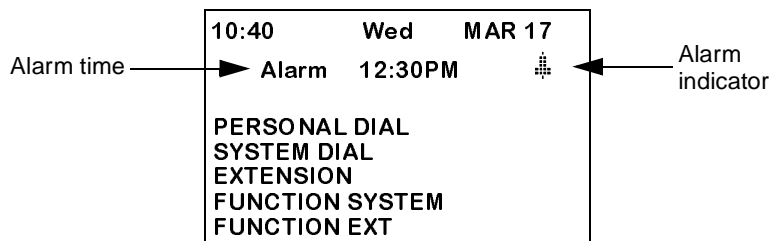

Figure 13. Incoming outside call for large-display phone

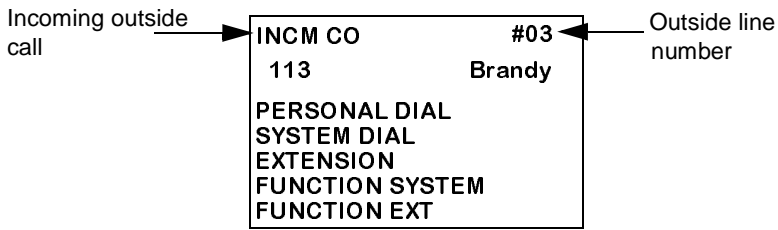

Figure 14. Outside call in progress for large-display phone

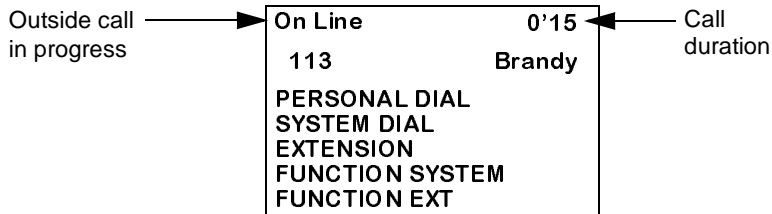
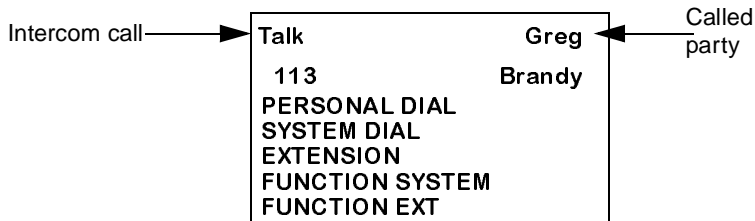

Figure 15. Internal calling in use for large-display phone



2. SETTING UP YOUR PHONE

You can use the procedures in this chapter to customize your phone for the following:

- Adjusting Volume and Display Settings (page 18)
- Setting Up Flexible Function Keys (page 19)
- Setting Up One-touch Keys (page 20)
- Setting Up Speed Dialling (page 22)
- Assigning and Deleting Personal Speed Dial (PSD) Numbers (page 22)
- Linking System Speed Dial Numbers (page 25)
- Assigning and Deleting Names for PSD Numbers (page 26)

ADJUSTING VOLUME AND DISPLAY SETTINGS

You can adjust the volume or display contrast of the following by pressing the **VOLUME** key:

- Intercom and incoming ringer
- Handset
- Speaker
- Display contrast of your phone

▶ To adjust the volume of your phone while it is in use

1. Press the **VOLUME** key:
 - a. During *ringing* to adjust the intercom or incoming ring tone.
 - a. During *a call* to adjust the handset or speaker volume.

▶ To adjust the ringer volume of your phone while it is idle

1. Press the **ON/OFF** key.
2. Press the **PROG** key.
3. Enter **9**, then **1** to adjust the *incoming* ring tone. (The phone produces a tone.)

OR

Enter **9**, then **2** to adjust the *intercom* ring tone. (The phone produces a tone.)

4. Press the **VOLUME** key.
5. Press the **ON/OFF** key.

▶ To adjust the display contrast of your phone

Note: This task requires a display phone.

1. While the phone is idle, press the **#** key.
2. Press the **VOLUME** key several times as needed.

SETTING UP FLEXIBLE FUNCTION KEYS

You can set up Flexible Function (FF) keys to initiate system features or to assign specific extension numbers.

Note: You cannot set up FF keys that are dedicated to outside lines. Contact your system administrator or ICX dealer to make changes to dedicated FF keys.

▶ To set up FF keys

1. Pickup the handset or press the **ON/OFF** key.
2. Press the **PROG** key.
3. Press the FF key to be programmed.
4. Do one of the following:

If . . .	Then . . .
You want one-key access to a certain feature: Notes: <ul style="list-style-type: none"> • You must enter a <i>dial code</i> when assigning features. (See Chapter A, "Dial Code List" on page 63.) • Not all dial codes can be stored in FF keys 	<ol style="list-style-type: none"> a. For a <i>fixed dial code</i>, press the REDIAL key. For a <i>flexible dial code</i>, proceed to step b. b. Enter one of the dial codes listed in Appendix A, "Dial Code List." Note:
** You want one-key access to a specific extension number, plus the ability to pick up the extension's calls and know when the extension is busy.	Enter the extension number.

If . . .	Then . . .
**If you assign an extension number to an FF key, the FF key will light red when the extension is busy. It will light green when Do-Not-Disturb (DND) or Call Forwarding is set. In addition, you can pick up a call that is ringing or on hold at the extension by simply pressing the FF key when it is flashing.	

5. Press the **HOLD** key.
6. Repeat steps 2-5 to program additional keys.
7. Replace the handset or press the **ON/OFF** key.

▶ To clear an FF key's programming

1. Pick up the handset or press the **ON/OFF** key.
2. Press the **PROG** key.
3. Press the desired FF key.
4. Press the **HOLD** key.
5. Replace the handset or press the **ON/OFF** key.

▶ To check the FF key's setup

Note: This task requires a display phone.

1. Pick up the handset or press the **ON/OFF** key.
2. Press the **CONF** key.
3. Press the FF key. The assigned function appears on the display.
4. Replace the handset or press the **ON/OFF** key.

SETTING UP ONE-TOUCH KEYS

You can set up one-touch keys on a non-display or small-display phone to store phone numbers, speed dial numbers, or feature access codes.

▶ To program a one-touch key for an outside phone number

1. Pickup the handset or press the **ON/OFF** key.
2. Press the **PROG** key.
3. Press the one-touch key to be programmed.

4. Dial the phone number to be stored.
5. Press the **HOLD** key.
6. Replace the handset or press the **ON/OFF** key.

▶ **To assign an SSD number to a one-touch key**

1. Pickup the handset or press the **ON/OFF** key.
2. Press the **PROG** key.
3. Press the one-touch key to be programmed.
4. Press the **MEMORY** key.
5. Enter the SSD bin number to be programmed.
6. Press the **HOLD** key.
7. Replace the handset or press the **ON/OFF** key.

▶ **To assign a feature code or extension number to a one-touch**

Note: **When the system is set up for MCO Code level, one-touch keys automatically dial an outside line. (MCO Code level requires system programming.)

1. Pickup the handset or press the **ON/OFF** key.
2. Press the **PROG** key.
3. Press the one-touch key to be programmed.
4. **If the feature functions at the MCO Code level, press **MEMORY * #**.
5. Enter the desired feature code or extension number.
6. Press the **HOLD** key.
7. Replace the handset or press the **ON/OFF** key.

▶ **To check a programmed one-touch key**

Note: This task requires a display phone.

1. Pickup the handset or press the **ON/OFF** key.
2. Press the **CONF** key.

3. Press the one-touch key to be checked. (Programmed data appears on the display.)
4. Replace the handset or press the **ON/OFF** key.

SETTING UP SPEED DIALLING

You can set up the following speed dial features using your phone's one-touch or soft keys:

- Speed dial numbers
- Speed dial linking
- Speed dial names

Assigning and Deleting PSD Numbers

You can assign frequently called numbers (or System Speed Dial [SSD] numbers) to your phone's one-touch or soft keys. These keys are preprogrammed to correspond to specific PSD codes or bins. You store your PSD numbers in these bins. When you press a one-touch or soft key containing a PSD number, the PSD bin associated with that key is accessed and the speed dial number is dialled.

You can assign up to 10 PSD numbers to the one-touch keys on a non-display or small-display phone (PSD bins **80-89**) and up to 20 PSD numbers to the soft keys on a large-display phone (PSD bins **80-99**).

When in the PSD Directory Mode, you can view the PSD bin numbers on the display. On a small-display phone, two bins are displayed at a time. To display the next two bins, press the # key. To display the previous two bins, press the * key. On a large-display phone, 10 PSD bins are displayed at a time. To display the next 10 bins, press the **NEXT** key. To display the previous 10 bins, press the **PREV** key.

For a list of corresponding PSD bin numbers and one-touch or soft keys, see Figure 16 and Table 4 on page 23.

Notes:

- On a small-display phone, you must be in the PSD Directory Mode to assign, access, or view numbers in PSD bins **90-99**. On a non-display phone, you access or assign numbers to PSD bins **90-99** by pressing the **MEMORY** key and entering the PSD bin number. (To review the PSD numbers on non-display phones, refer to your customized list of PSD numbers in Appendix B "Customized PSD Bin Numbers" on page 66.)
- Until you assign a name or string of characters to a PSD number, the PSD bin number will display when you press the one-touch or soft key. For more information, see "Assigning and Deleting Names for PSD Numbers" on page 26.

- You can check PSD numbers or names that have been assigned to one-touch or soft keys. For more information, see “Checking Speed Dial Numbers” on page 36.

Figure 16. One-touch and soft key numbering scheme

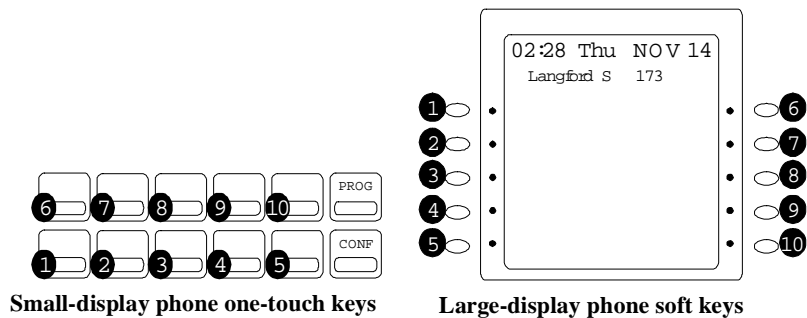

Table 4. Corresponding one-touch or soft keys and PSD bin numbers

One-touch or soft key	Corresponds to PSD bin on ...	
	Small-display and non-display phones	Large-display phone
1	80	80 or 90
2	81	81 or 91
3	82	82 or 92
etc.		

▶ To assign a PSD number to a one-touch or soft key

Note: Before assigning PSD numbers, you must determine whether the system is set up for Intercom Level (programmed to dial an inside line) or MCO Code level (programmed to dial an outside line). Depending on the system set up, you must include the appropriate dialling code as part of the PSD number. To determine which code to use, see Table 5 on page 24.

1. Pick up the handset or press the **ON/OFF** key.
2. Either:
 - Press the **PROG** key and then press the **MEMORY** key.

OR

- Enter the Speed Dial Set/Clear code (default = 710).
3. Enter the PSD bin number (**80-99**).
 4. Enter the phone number you want to be speed-dialled (maximum length = 16 characters). Remember to include the Intercom Level or MCO Code level code depending on how the system is set up. (Refer to the following table.)

Table 5. Characters allowed when assigning PSD numbers

To insert a . . .	Enter/Press...
Digit or character	0, 1-9, *, #
Intercom Level*	MEMORY * #
MCO Code**	MEMORY * 0
Pause	REDIAL
Hyphen (-) (Appears when the number is dialled or checked, but not during programming.)	
* Indicates that the digits that follow are either a feature access code or extension number. (Do not include if system is set for Intercom Level.) ** Indicates that the digits that follow are for an outside number. (Do not include if system is set for CO Level.)	

5. Press the **HOLD** key.
6. Replace the handset or press the **ON/OFF** key.

▶ To delete a PSD number assigned to a one-touch or soft key

Note: When deleting a PSD number from a non-display phone, be sure to record the change in your personalized list of PSD numbers. (See Appendix B, “Customized PSD Bin Numbers.” on page 66.)

1. Pick up the handset or press the **ON/OFF** key.
2. Either:
 - Press the **PROG** key and then press the **MEMORY** key.

OR

- Enter the Speed Dial Set/Clear code (default = 710).
3. Enter the PSD bin number (**80-99**).
 4. Press the **HOLD** key.

5. Replace the handset or press the **ON/OFF** key.

Assigning SSD Numbers

Note: SSD numbers require system programming.

SSD numbers are numbers that are frequently called by many different individuals at your location; such as a branch or corporate office, a package delivery service, or a travel agent. SSD numbers must be programmed from the attendant's phone. Once programmed, they are available for everyone to use.

A maximum of 80 or 800 SSD numbers are allowed, depending on the system. In an 80 SSD number system, SSD numbers are stored in bins **00-79**. In an 800 SSD system, SSD numbers are stored in bins **000-799**. You dial SSD numbers by entering the appropriate bin number or by using one-touch or soft keys. For more information, see "Dialling Speed Dial Numbers" on page 34.

Note: To dial an SSD number using the one-touch keys on a non-display or small-display phone, you must first assign the SSD number to a PSD bin number. For more information, see "Assigning and Deleting PSD Numbers" on page 22.

Linking System Speed Dial Numbers

To handle phone numbers longer than 25 characters, you can link up to six SSD numbers in one PSD bin. You can then dial the entire number (each SSD number contained in the chain) by pressing the programmed PSD key or by entering the speed dial bin number.

Notes:

- Before linking multiple SSD numbers to a PSD bin, the SSD bins must already have been programmed with the appropriate speed dial information. (This requires system programming.)
- If numbers do not appear on the display (**00-79** or **000-799**) when you use SSD codes, your extension is not programmed to display that data.

▶ To link speed dial numbers to a PSD bin

1. Pick up the handset or press the **ON/OFF** key.
2. Either:
 - Press the **PROG** key and then press the **MEMORY** key.

OR

 - Enter the Speed Dial Set/Clear code (default = 710).
3. Press the soft or one-touch key (for the PSD bin [**80-99**]) to be programmed.

4. Press the **MEMORY** key.
5. Enter the SSD bin number that contains the first part of the number to be dialled. (If a pause is required, press the **REDIAL** key.)
6. Repeat steps 4-5 (up to 5 more times) for each remaining SSD number to be linked.
7. Press the **HOLD** key when you are finished.
8. Replace the handset or press the **ON/OFF** key.

▶ To use a PSD key that links multiple speed dial numbers

1. If necessary, select the trunk group (**9, 81-84**) to access an outside line. (Normally the trunk is selected by the speed dial numbers.)
2. Press the PSD key.

Assigning and Deleting Names for PSD Numbers

After assigning a PSD number to a one-touch or soft key, you can assign a name to the key (e.g., "Home," "John," etc.). You can then view the assigned PSD name when you are in the PSD Directory mode.

Note: You need to know the PSD bin number for PSD number in order to assign a name to it. To determine the bin number, see "Checking Speed Dial Numbers" on page 36.

▶ To assign a name to a PSD number

Note: This task requires a display phone.

1. Pick up the handset or press the **ON/OFF** key.
2. Press the **PROG** key.
3. Press the * key.
4. Enter **0** for the Name Assignment mode.
5. Press the **▼ VOLUME ▲** key until the desired PSD bin number (**80-99**) is displayed.
6. Press the **FL/R** key to clear the current/default data.
7. (A) For a **small-display** phone (see Figure 17 on page 28 for an example):
 - a. Press the appropriate one-touch key for the desired group of letters.

- b.** Use the bottom row of FF keys to define your selection.
- c.** Repeat steps a-b as many times as necessary to enter the desired name.
 - Press the * key to erase an entry.
 - Press the # key to enter a space.

(B) For a **large-display** phone (see Figure 18 on page 29 for an example):

- a.** Press the appropriate soft key next to the desired row of letters.
- b.** Use the bottom row of FF keys to define your selection.
- c.** Repeat steps **a-b** as many times as necessary to enter the desired name.
 - Press the * key to erase an entry.
 - Press the # key to enter a space.

8. Press the **HOLD** key when the name is complete.

9. To enter another speed dial name, repeat steps 5-8.

10. Hang up or press **ON/OFF**.

Figure 17. Name assignment example - small-display phone

To enter a **D**:

- a** Press the first one-touch key from the left on the bottom row.
- b** Press the fourth FF key from the left on the bottom row.

To enter an **o**:

- c** Press the third one-touch key from the left on the top row.
- d** Press the third FF key from the left on the bottom row.

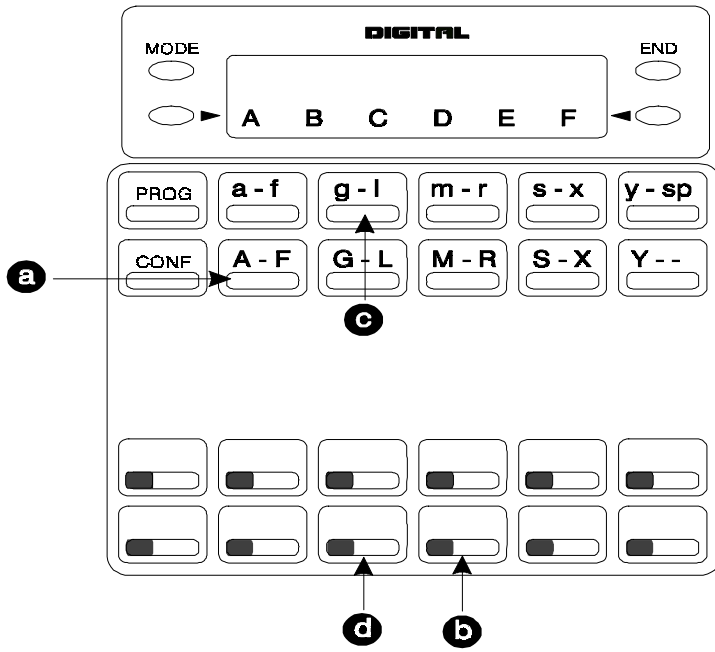
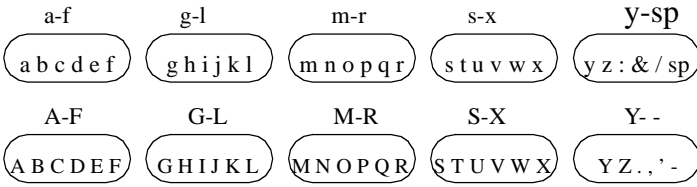

Figure 18. Name assignment example - large-display phone

To enter a **D**:

- a** Press the first soft key on the top left.
- b** Press the fourth FF key from the left on the bottom row.

To enter an **o**:

- c** Press the third soft key from the top right.
- d** Press the third FF key from the left on the bottom row.

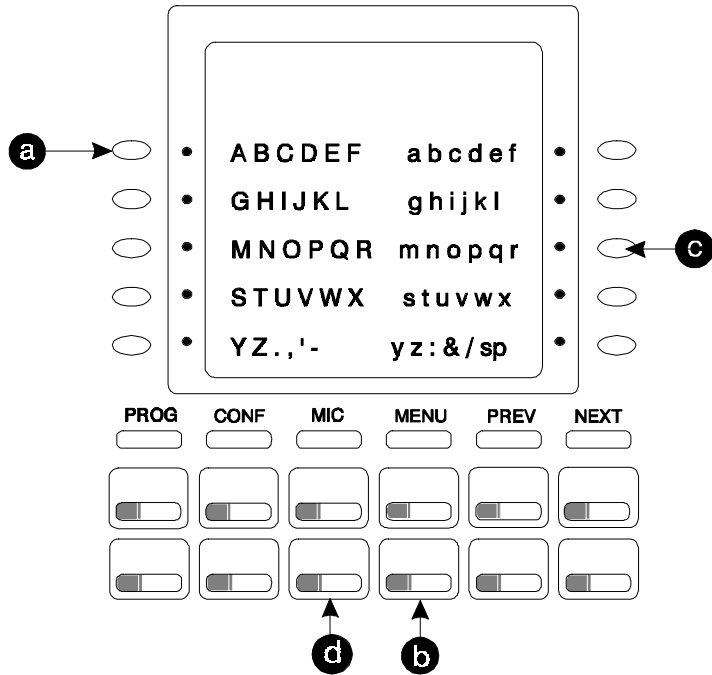

▶ To delete a name assigned to a PSD number

Notes:

- This task requires a display phone.
- You need to know the PSD bin number for the PSD number in order to delete an assigned name. To check the bin number for a key, see “Checking Speed Dial Numbers” on page 36.

1. Pick up the handset or press the **ON/OFF** key.
2. Press the **PROG** key.
3. Press the * key.
4. Enter **0** for the Name Assignment mode.
5. Press the ▼ **VOLUME** ▲ key until the desired PSD bin number (**80-99**) is displayed.
6. Press the **FL/R** key to clear the current/default data.
7. Press the **HOLD** key.

Notes:

- It is strongly recommended that you assign the PSD bin number as a name for the key at this point so that it will appear on the display for future use. The bin number should be entered in the following format: “-PSDxx (or xxx)” where xx or xxx = the actual bin number. Example: “-PSD901”. For more information, see “Assigning and Deleting Names for PSD Numbers” on page 26.
- If using a large-display phone, press the **MENU** key, then the key to the left of **PERSONAL DIAL** to have the change reflected on the display.

3. PLACING OUTSIDE CALLS

Your digital phone, in conjunction with the ICX, provides the following ways for you to place outside calls:

- Accessing an Outside Line (page 31)
- Using Account Codes (page 32)
- Redialing Outside Numbers (page 33)
- Using Speed Dialling (page 34)

ACCESSING AN OUTSIDE LINE

You can place outside calls using the following features or under the following conditions:

- Outside line access group code
- Flexible Function (FF) keys
- Open line call back

▶ To make an outside call using an outside line access code

1. Pick up the handset or press the **ON/OFF** key.
2. Enter an access code for an outside line access group (**9, 81-84**).
3. Dial the phone number.

Notes:

- If all outside lines in the group are busy, you will hear a busy tone.
- If the system is set up for Automatic Route Selection (ARS), dialling **9** automatically routes your call to a selected outside line.

▶ To make an outside call using an FF key

1. Pick up the handset or press the **ON/OFF** key.
2. Press an FF key that is dedicated to an outside line or to a group of outside lines.
3. Dial the phone number.

▶ To have a busy outside line call you back once it is open

1. Pick up the handset or press the **ON/OFF** key.
2. Attempt to access an outside line.
3. When you hear the busy tone, enter the Callback Request code (default = 3).
4. Press the **ON/OFF** key again and wait for the callback tone. (When the outside line is available, your phone rings and the FF key for the outside line flashes.)
5. Pick up the handset or press the **ON/OFF** key.
6. Dial the phone number.

Note: You must respond to the callback tone within 15 seconds.

USING ACCOUNT CODES

You can assign account codes (both non-verified account codes and verified ID codes) to clients to help track a variety of information; such as, call dates and times, numbers called, and outside line numbers used. This information is then printed for each account on a System Message Detail Recording (SMDR) record.

Note: An SMDR printer or external call accounting system is required to collect account code records.

Non-verified Account Codes

Non-verified account codes are voluntary and do not have to be entered before you make a call. They can also be assigned to both incoming and outgoing calls.

You can enter a non-verified account code before making a call or during a call.

▶ To enter a non-verified account code before making a call

1. Pick up the handset or press the **ON/OFF** key.
2. Enter the Account Code code (default = 8#).
3. Enter the Account Code (up to 10 digits).
4. Press the # key.
5. Dial 9 or press an FF key that is dedicated to an outside line.
6. Dial the phone number.

▶ To enter a non-verified account code during a call

1. During a call, press the **MEMORY** key.
2. Press the **#** key.
3. Enter the Account Code (up to 10 digits).
4. Press the **#** key.

Verified Account Codes

Verified ID codes are required by extensions that have restrictions on placing outgoing calls (i.e., a specific code is required to place an outgoing call).

▶ To make an outside call that requires an account code

1. Pick up the handset or press the **ON/OFF** key.
2. Enter the Verified Account code feature access code (default = 8#).
3. Enter the Verified Account code. The entered code may be up to 10 digits.
4. Press the **#** key.
5. Dial 9 or press an FF key that is dedicated to an outside line.
6. Dial the phone number.

REDIALING OUTSIDE NUMBERS

You can use the **REDIAL** key to redial the last number dialled or to redial a busy number.

▶ To redial the last number dialled

1. Pick up the handset or press the **ON/OFF** key.
2. Access an outside line.
3. Press the **REDIAL** key. (The phone displays and dials the last outside number dialled.)

▶ To automatically redial a busy number

Note: The system will continue to redial the busy number until you hang up the phone, the called party answers the call, or a maximum of 15 redial attempts is made.

1. Pickup the handset or press the **ON/OFF** key.
2. Access an outside line.
3. Dial the phone number.
4. After hearing the busy tone, press the **REDIAL** key. (The phone continues to dial the busy number until the caller answers or the redial timer times out.)

▶ To cancel automatic repeat dialling

1. Replace the handset or press the **ON/OFF** key.

USING SPEED DIALLING

After PSD numbers and SSD numbers have been assigned, you can quickly dial the number by pressing the appropriate one-touch or soft key or by entering the appropriate speed dial bin number. (For information on assigning PSD and SSD numbers, see “Setting Up Speed Dialling” on page 22.) You can also check and see what PSD and SSD number or name is assigned to specific one-touch or soft keys.

Notes:

- For information on deleting PSD numbers, see “Assigning and Deleting PSD Numbers” on page 22.
- You cannot delete SSD numbers assigned to one-touch or soft keys. These numbers are programmed from the attendant’s phone.

Dialling Speed Dial Numbers

You can dial speed dial numbers by using preassigned one-touch keys on non-display or small-display phones, using soft keys and speed dial directories, or by entering speed dial bin numbers.

▶ To dial a speed dial number by pressing a one-touch key

1. Pickup the handset or press the **ON/OFF** key.
2. If necessary, access an outside line.
3. Press the desired one-touch key.

▶ To dial a speed dial number using the soft keys on a small-display phone

1. Press the **MODE** key one time. (**SSD** and **PSD** appear on the second line of the display.)

2. Press the soft key next to **SSD** or **PSD**. (The first two speed dial entries appear on the second line of the display.)
3. Scroll through the speed dial directory until the desired speed dial entry is displayed. (To display the next two entries, press the # key. To display the previous two entries, press the * key.)
4. Pick up the handset or press the **ON/OFF** key.
5. If necessary, access an outside line.
6. Press the soft key next to the desired speed dial entry to initiate dialling.

▶ **To dial a speed dial number using the soft keys on a large-display phone**

1. From the Main Menu, press the soft key to the left of **SYSTEM DIAL** or **PERSONAL DIAL**. (In the PSD directory, the first 10 speed dial entries are displayed. In the SSD directory, 10 alphabetical entries are displayed.)

2. For the PSD directory, proceed to step 3.

For the SSD directory, press the soft key to the left of the desired group of letters to display the first five speed dial entries.

3. Scroll through the speed dial directory until the desired speed dial entry is displayed. (To scroll forward in either directory, press the **NEXT** key. To scroll backwards in either directory, press the **PREV** key.)
4. Pick up the handset or press the **ON/OFF** key.
5. If necessary, access an outside line.
6. Press the soft key next to the desired speed dial entry to initiate dialling.

▶ **To dial a speed dial number by entering the speed dial bin number**

Note: You must know the PSD or SSD bin number for the number to be dialled to perform this task. For information on determining speed dial numbers, see ““Checking Speed Dial Numbers” on page 36.

1. Pick up the handset or press the **ON/OFF** key.
2. If necessary, access an outside line.
3. Press the **MEMORY** key.

4. Enter the appropriate three digit speed dial bin number (PSD bins **80-99** or SSD bins **00-79** or **000-799**).

Checking Speed Dial Numbers

After speed dial numbers have been assigned, you can check to see what number has been programmed by using soft keys or by entering the speed dial bin number.

Note: The following tasks require a display phone. To check speed dial numbers on a non-display phone, see Appendix B, “Customized PSD Bin Numbers” on page 66 for your personalized list of speed dial numbers.

▶ To check a speed dial number using the soft keys on a small-display phone

1. Press the **MODE** key one time. (**SSD** and **PSD** appear on the second line of the display.)
2. Press the soft key next to **SSD** or **PSD**. (The first two speed dial entries appear on the second line of the display.)
3. Scroll through the speed dial directory until the desired speed dial bin entry is displayed. (To display the next two entries, press the **#** key. To display the previous two entries, press the ***** key.)
4. Pick up the handset or press the **ON/OFF** key.
5. Press the **CONF** key.
6. Press the soft key next to the speed dial entry. (The speed dial number appears on the display.)

▶ To check a speed dial number using the soft keys on a large-display phone

1. From the Main Menu, press the soft key to the left of **SYSTEM DIAL** or **PERSONAL DIAL**. (In the PSD directory, the first 10 speed dial entries are displayed. In the SSD directory, 10 alphabetical entries are displayed.)
2. For the PSD directory, proceed to step 3.

For the SSD directory, press the soft key to the left of the desired group of letters to display the first five speed dial entries.

3. Scroll through the speed dial directory until the desired speed dial entry is displayed. (To scroll forward in either directory, press the **NEXT** key. To scroll backwards in either directory, press the **PREV** key.)

4. Pick up the handset or press the **ON/OFF** key.
5. Press the **CONF** key.
6. Press the soft key next to the speed dial entry. (The speed dial number appears on the first line of the display. The speed dial bin number appears on the second line of the display, along with any name that has been assigned to the speed dial number.)

▶ **To check speed dial entries by entering the speed dial bin number**

1. Pick up the handset or press the **ON/OFF** key.
2. Press the **CONF** key.
3. Press the **MEMORY** key.
4. Enter the appropriate PSD bin number (**80-99**) or SSD bin number (**00-79** or **000-799**). (The speed dial number appears on the first line of the display. The speed dial bin number appears on the second line of the display, along with any name that has been assigned to the speed dial number.)

4. HANDLING INCOMING CALLS

You can handle calls that reach your phone in a variety of ways:

- Answer Calls (page 38)
- Use Call Hold (page 38)
- Transfer Calls (page 40)

ANSWERING CALLS

You can answer various types of calls using the following procedure:

► To answer a call

1. Pick up the handset or press the **ON/OFF** key.
2. Do one of the following:

To answer . . .	Do the following . . .
A call ringing at someone else's phone	<p>a. Press the flashing FF key.</p> <p style="text-align: center;">OR</p> <p>a. Enter the Direct Call Pickup Set code (<u>default = 704</u>).</p> <p>b. Dial the number of the ringing extension.</p>
A call ringing a phone within your call pickup group	Enter the All Calls Pickup Set code (<u>default = 701</u>).
An external call ringing a phone within your call pickup group	Enter the External Call Pickup Set code (<u>default = 702</u>).
A call ringing outside your call pickup group	<p>a. Enter the Specified Group Pickup Set code (<u>default = 703</u>).</p> <p>b. Enter the number of the call pickup group (01-72) where the phone is ringing.</p>

3. Complete the call, and replace the handset or press the **ON/OFF** key.

USING CALL HOLD

Depending on the set up of your system, you can put one or more calls on hold and retrieve those calls using the **HOLD** key or a designated Floating Hold key.

Notes:

- The Floating Hold feature assigns a Floating Hold number (**001-576**) to a specific FF key. By placing a call on hold using the Floating Hold key, you can retrieve the call from any phone that has an FF key that is assigned the same Floating Hold number or by simply entering the Floating Hold number.
- Floating Hold requires system programming.
- The **EXT** indicator flashes when you hold an internal call or an outside line that is not assigned to an FF key.
- If you do not pick up a held call in a certain period of time, you will hear a tone indicating that the call is still waiting.

▶ **To place a call on hold**

1. While on a call, press the **HOLD** key or the Floating Hold FF key.

▶ **To use Broker's Hold and toggle between two calls**

1. While on a call, press the **HOLD** key to put the first call on hold.
2. Press the FF key that is flashing green to answer the second call.
3. Press the **HOLD** key to put the second call on hold.
4. Press the FF key that is flashing green to return to the first call.

▶ **To retrieve a call placed on hold, do one of the following:**

To retrieve a call . . .	Do . . .
From the extension that placed the call on hold	Press the FF key that is flashing green. OR Press the HOLD key (if no FF key is flashing).
From a different extension than the one that placed the call on hold	Press the FF key that is flashing red.
From Floating Hold (also known as System Park Pick Up)	a. Press the Floating Hold FF key. OR a. Enter the Floating Hold Answer code (<u>default</u> <u>≡ *9</u>). b. Enter the Floating Hold number for the held call (001-576).

TRANSFERRING CALLS

You can transfer a call to an open extension, a busy extension, or an outside line. These transfers can be either supervised or unsupervised.

Note: If a transferred call is not answered within a specified time, the call rings again at the extension that transferred it.

Supervised Transfers

In a supervised transfer, you announce the call before transferring it. This allows you to give the recipient information about the call.

► To supervise the transfer of a call to another extension or an outside number

1. While on a call, press the **HOLD** key.
2. Either dial the extension number or the outside line number to which the call will be transferred.
3. When the recipient answers, announce the call.
4. Complete the call by doing one of the following:
 - a. If On-hook Transfer is enabled for your extension, replace the handset or press the **ON/OFF** key.
 - b. If On-hook Transfer is disabled for your extension, press the **PROG** key.

Note: On-hook Transfer requires system programming.

Unsupervised Transfers

In an unsupervised transfer, you do not announce the call to the person receiving the transfer. You hang up before the recipient answers the call.

► To transfer a call to another extension or an outside number without supervising the call

1. While on a call, press the **HOLD** key.
2. Either dial the extension number or the outside line number to which the call will be transferred.
3. Complete the call by doing one of the following:

- a. If On-hook Transfer is enabled for your extension, replace the handset or press the **ON/OFF** key.
- b. If On-hook Transfer is disabled for your extension, press the **PROG** key.

Note: On-hook Transfer requires system programming.

► To transfer a call to a busy extension

1. While on a call, press the **HOLD** key.
2. Dial the extension number to which the call will be transferred.
3. If your extension does not have Auto Camp-on activated, enter the Camp-on (Call Waiting) Set code (default = 2). Otherwise proceed to step 4.
4. Complete the call by doing one of the following:
 - a. If On-hook Transfer is enabled for your extension, replace the handset or press the **ON/OFF** key.
 - b. If On-hook Transfer is disabled for your extension, press the **PROG** key.

Note: On-hook Transfer requires system programming.

CALL PICKUP

The System allows the following types of Call Pickup:

- Extension Group Pickup
- Extension Direct Pickup
- Trunk Group Pickup
- Trunk Direct Pickup

Extension Group Pickup

Extension Group Pickup allows you to pick up a direct ringing call (within your extension pickup group or in a different extension pickup group) without having to dial the number of the ringing extension.

Three types of Extension Group Pickup are available:

- **Call Pickup-All Calls:** you can pick up a direct call ringing anywhere within your own extension group.
- **Call Pickup-External Calls:** You can pick up only direct external calls ringing within your own extension group.

- **Specified Group Pickup:** You can pick up a call ringing to an extension in another extension group.

▶ To use Extension Group Pickup - All Calls

1. Lift the handset or press the **ON/OFF** key.
2. Enter the Extension Group Pickup- All Calls code (default=701).
3. Complete the call and replace handset or press the **ON/OFF** key.

▶ To use Extension Group Pickup - External Calls

1. Lift the handset and press the **ON/OFF** key.
2. Enter the Extension Group Pickup-External Calls code (default=702).
3. Complete the call and replace the handset or press the **ON/OFF** key.

▶ To use Specified Group Pickup - All Calls

1. Lift the handset or press the **ON/OFF** key.
2. Enter the Specified Group Pickup access code (default=703).
3. Enter the number of the Call Pickup Group (01-72) where the call is ringing.
4. Complete the call and replace the handset or press the **ON/OFF** key.

Extension Direct Pickup

Extension Direct Pickup allows you to answer a call to another extension by dialling the number of the ringing extension.

▶ To use Extension Direct Pickup

1. Lift the handset or press the **ON/OFF** key.
2. Enter the Extension Direct Call Pickup code (default=704).
3. Dial the number of the ringing extension.
4. Complete the call and replace the handset or press the **ON/OFF** key.

Trunk Group Pickup

Trunk Group Pickup allows you to answer calls ringing to any extension within your own MCO incoming trunk group.

▶ To use Trunk Group Pickup

1. Lift the handset or press the **ON/OFF** key.
2. Enter the Trunk Group Pickup code (default=709).
3. Complete the call and replace the handset or press the **ON/OFF** key.

Trunk Direct Pickup

Trunk Direct Pickup allows you to answer calls ringing on a specific trunk number.

▶ To use Trunk Direct Pickup

1. Lift the handset or press the **ON/OFF** key.
2. Enter the Trunk Direct Pickup code (default=*0).
3. Dial the number of the ringing trunk.
4. Complete the call and replace the handset or press the **ON/OFF** key.

CALL PARK

You can use the Call Park function to transfer a call, even if you cannot locate the intended recipient of the call.

There are two ways for an extension to park a call on the DBS. One way is to park the call at the receiving extension and to retrieve the call at another extension by dialling the park answer code plus the parking extension number. The other way is to park the call at another extension and dial the park transfer answer code at the other extension to retrieve the call.

▶ To park a call on this extension

1. While on a call, press the **HOLD** key.
2. Enter Call Park access code (default=771) or press the **PARK HOLD** key.
3. If necessary, page the party that needs to receive the call.

▶ To retrieve a call parked at another Extension

1. Lift the handset or press the **ON/OFF** key.
2. Enter the Call Park Answer/Other Extension access code (default=773).
3. Dial the number of the extension that parked the call.

▶ To park a call at another extension

1. While on a call, press the **HOLD** key.
2. Enter the Call Park Transfer access code (default 774) followed by the extension number to receive the parked call.

▶ To retrieve a call parked on this extension

1. At the extension with the transferred park call, lift the handset or press the **ON/OFF** key.
2. Enter the Call Park Answer/Self Access Code (default=772).
3. If necessary, page the party that needs to retrieve the call.

5. COMMUNICATING WITHIN YOUR OFFICE

The ICX provides a variety of ways to handle calls within your office:

- Calling Other Extensions (page 45)
- Switching Between Tone and Voice Calling (page 46)
- Using Paging (page 47)
- Making Announcements to Busy Extensions (page 48)
- Using Call Forwarding (page 49)
- Using Camp-on (Call Waiting) (page 51)
- Using Message Waiting/Callback (page 52)
- Using Do-Not-Disturb (page 53)

CALLING OTHER EXTENSIONS

You can call other extensions by entering the extension number or by using the soft keys and Extension Directory. While making a call, you can also specify whether to use tone calling or voice calling.

▶ To call another extension by entering the extension number

1. Pick up the handset or press the **ON/OFF** key.
2. Dial the desired extension or dial **0** for the operator.

▶ To call another extension using the soft keys on a small-display phone

1. Press the **MODE** key twice. (**EXT** appears on the second line of the display.)
2. Press the soft key next to **EXT**. (The first two extension entries appear on the second line of the display.)
3. Scroll through the directory until the desired extension entry is displayed. (To display the next two entries, press the **#** key. To display the previous two entries, press the ***** key.)
4. Pick up the handset or press the **ON/OFF** key.
5. Press the soft key next to the desired extension entry to initiate dialling.

► **To call another extension using the soft keys on a large-display phone**

1. From the Main Menu, press the soft key to the left of **EXTENSION**. (10 alphabetical entries are displayed.)
2. Press the soft key to the left of the desired group of letters to display the first five extension entries.
3. Scroll through the extension directory until the desired extension entry is displayed. (To scroll forward, press the **NEXT** key. To scroll backwards, press the **PREV** key.)
4. To scroll forward in the directory, press the **NEXT** key. To scroll backwards in the directory, press the **PREV** key.
5. Pick up the handset or press the **ON/OFF** key.
6. Press the soft key next to the desired extension entry to initiate dialling.

Switching Between Tone and Voice Calling

You can call another extension using tone calling or voice calling. Tone calling sends a ringing tone to the called extension, where voice calling performs like an intercom call and connects immediately without ringing the extension. (If desired, the called party can answer a voice call without lifting the handset.)

System programming determines the default calling mode; however, you can switch between tone and voice calling by entering **1**.

► **To switch between tone to voice calling**

1. Lift the handset or press the **ON/OFF** key.
2. Dial the extension number.
3. If your phone is set for tone calling and you want to make a voice call, enter **1**. (Or if your phone is set for voice calling and you want to make a tone call, enter **1**.)
4. Speak when the call is answered.
5. Replace the handset or press the **ON/OFF** key.

USING PAGING

You can make both internal and external pages and announcements. Internal pages are made via the key telephone speakers and external pages are made through the speakers of an external paging system connected to the ICX system. When you issue a page, you specify a paging group so that your announcement is heard only on the phones that are members of that group.

You can answer a page from any extension using the Meet-Me Answer feature.

Note: You can belong to more than one paging group.

▶ To page another party or make an announcement

1. Pick up the handset or press the **ON/OFF** key.
2. Enter the Page Group code (default = #).
3. Enter the number of the desired page group (**0-9**).
4. Make your announcement.
5. Do one of the following:

If ...	Then ...
You want to end the page	Replace the handset or press the ON/OFF key. Note: To avoid an abrupt "hang-up" sound, press the FL/R key before replacing the handset.
You want to get a response from someone answering the page at an extension	Do not hang up; wait for the paged party to answer.

Answering a Page (Meet-Me Answer)

You can answer a page from any extension using the Meet-Me Answer feature.

▶ To answer a page using Meet-Me Answer

1. Pick up the handset or press the **ON/OFF** key.
2. Enter the Meet-Me Answer code (default = ##). (You are connected to the party trying to reach you.)

MAKING ANNOUNCEMENTS TO BUSY EXTENSIONS

Note: This feature requires system programming or a specific ICX configuration, and may not be available. For information, see your system administrator or ICX dealer.

This feature (also known as Off-Hook Voice Announcement) allows you to make an announcement to a busy extension.

If party you called is using a digital key telephone, the announcement is heard only by the called party, not by the other party he or she is talking to. If, however, the party you called is using a single-line telephone, both the called party and the party he or she is talking to will hear the announcement.

► To make an announcement

1. Pick up the handset or press **ON/OFF**.
2. Dial the extension number.
3. Press **8** if you hear the busy tone.
4. Make your announcement. (Your voice is heard on the extension, not on the other line.)

Answering an Announcement

To answer an announcement, you can use the OHVA Split key to speak to the announcing party or you may send a text message.

The OHVA Split key is an FF key that has been assigned to the OHVA function. The OHVA function is typically used in situations where the extension user must handle more than one call. The Split key must be set up by the system administrator or dealer.

► To speak to the announcing party

1. While on a call, press the OHVA Split key.
2. Speak with the announcing party.
3. Press the OHVA Split key to return to the original call.

Transferring Calls with an Announcement

Note: This feature requires system programming or a specific ICX configuration, and may not be available. For information, see your system administrator or ICX dealer.

► To transfer a call while making an announcement

1. While remaining on the line with the original party, press the **HOLD** key.
2. Dial the extension number.
3. When you hear a busy tone, press **8**.
4. Make your announcement.
5. When you are connected to the called party, replace the handset or press the **ON/OFF** key.

USING CALL FORWARDING

You can send or forward your calls to another extension, an outside line, or to voice mail from either your extension or from an alternate extension.

Notes:

- Any outside number used for Call Forwarding must already be programmed into system speed dialling.
- Calls cannot be forwarded to an extension that already has Call Forwarding set or Do-Not-Disturb (DND) turned on.
- The system allows you to cancel Call Forwarding and DND for your extension in one step.

► To set Call Forwarding

1. Pick up the handset or press the **ON/OFF** key.
2. Do one of the following:

To forward . . .	Do . . .
All incoming calls	Enter the appropriate Call Forwarding - All Calls Set code: <ul style="list-style-type: none"> • For your extension, enter 721 • For another extension, enter 741
All incoming calls that ring a busy extension	Enter the appropriate Call Forwarding - Busy Set code: <ul style="list-style-type: none"> • For your extension, enter 722 • For another extension, enter 742

To forward . . .	Do . . .
All incoming calls that ring an extension that doesn't answer	Enter the appropriate Call Forwarding - No Answer Set code: <ul style="list-style-type: none"> For your extension, enter 723 For another extension, enter 743

- If setting Call Forwarding for another extension, enter the number of the extension whose calls you are forwarding. Otherwise, proceed to step 4.
- Enter the destination code:
 - If you are forwarding to another extension, enter the extension number.
 - If you are forwarding to an outside number, press the # key and enter the system speed dial code.
- Replace the handset or press the **ON/OFF** key.

► To cancel Call Forwarding

- Pick up the handset or press the **ON/OFF** key.
- Do one of the following:

To cancel call forwarding . . .	Do . . .
For all incoming calls	Enter the appropriate Cancel Call Forwarding - All Calls code: <ul style="list-style-type: none"> For your extension, enter 731 For another extension, enter 751
For all incoming calls that ring a busy extension	Enter the appropriate Cancel Call Forwarding - Busy code: <ul style="list-style-type: none"> For <i>your extension</i>, enter 732 For another extension, enter 752
For all incoming calls that ring an extension that doesn't answer	Enter the appropriate Cancel Call Forwarding - No Answer code: <ul style="list-style-type: none"> For your extension, enter 733 For another extension, enter 753

- If cancelling Call Forwarding for another extension, enter the extension number whose Call Forwarding you are cancelling. Otherwise, proceed to step 4.
- Replace the handset or press the **ON/OFF** key.

▶ To cancel Call Forwarding and DND for your extension in one step

1. Pick up the handset or press the **ON/OFF** key.
2. Enter the Cancel Call Forwarding - DND code (default = 7**).

USING CAMP-ON (CALL WAITING)

Camp-on (Call Waiting) allows you to send a call waiting tone to a busy extension indicating that they have a call waiting. You then “camp-on” or stay on the line until the party you are trying to reach answers the call.

Note: Camp-on (Call Waiting) can be set manually or automatically. However, automatic Camp-on (Call Waiting) requires system programming.

▶ To manually camp-on to a line and notify a party that they have a call waiting

1. Pick up the handset or press the **ON/OFF** key.
2. Dial the extension number.
3. After you hear a busy tone, enter the Camp-on (Call Waiting) Set code (default = 2). (The Called party hears an alert tone and you hear a ringback tone.)
4. Stay on the line until the called party answer.

Notes:

- If call waiting is accepted, the busy tone changes to a ringing tone.
- You cannot send a call waiting message to an extension that has DND turned on.

▶ To use Automatic Camp-on (Call Waiting)

Note: Automatic Camp-on (Call Waiting) requires system programming.

1. Pick up the handset or press the **ON/OFF** key.
2. Dial the extension number. (The called party hears an alert tone and you hear ringback tone.)
3. Remain on the line until the called party answers.

▶ To answer a Camp-on (Call Waiting) signal

1. Do one of the following:

To ...	Do ...
Answer a call	<ol style="list-style-type: none"> a. After receiving an alert tone, replace the handset or press the ON/OFF key to end the first call. b. Lift the handset or press the ON/OFF key again to connect to the waiting call..
Toggle between two calls (using Broker's Hold)	<ol style="list-style-type: none"> a. After receiving an alert tone, press the HOLD key to put the first call on hold. b. Press the ON/OFF key to pick up the second call.

USING MESSAGE WAITING/CALLBACK

You can leave a callback request message (or message waiting indication) for a busy extension or one that does not answer. After sending the callback message, you hang up the phone and wait for the call back. The called party's message indicator lamp then flashes that a message has been received.

When the message indicator lamp flashes, it indicates either a callback message from another extension or, if your system uses voice mail, a voice message. For a callback message, the display reflects the extension or name that sent the message. For a voice message, the display reflects that a new message has been received.

If multiple messages have been received, the display reflects the number of messages and indicates the origin of the first message (i.e., the extension number or voice mail).

Note: You can use the **MSG** key to answer callback requests.

► To send a Message Waiting/Callback request

1. Pick up the handset or press the **ON/OFF** key.
2. Dial the extension number.
3. While the phone is still ringing or when you hear the busy tone, enter the Message Wait code (**default = 4**). (The message lamp flashes at the called extension.) (**Note:** You may need to dial **1** to change to tone calling before sending the message.)
4. Replace the handset or press the **ON/OFF** key.

► To respond to a Message Waiting/Callback request

Note: Multiple messages are accessed in the order in which they are received.

1. Pick up the handset or press the **ON/OFF** key.
2. Do one of the following:

To ...	Do ...
Answer a callback request	Enter the Message Wait/Callback Set code (<u>default = *6</u>). Or, press the MSG key. <ul style="list-style-type: none"> • Phone automatically dials the extension that sent the callback request • Message lamp goes off when the call is answered
* Cancel a Message Waiting/Callback request	Enter the Cancel Message Waiting/Callback code (<u>default = *5</u>).
* Only the person receiving a Message Waiting/Callback request can cancel the request. (The sender of a callback request cannot cancel the request once it has been sent.)	

3. Replace the handset or press the **ON/OFF** key.

USING DO-NOT-DISTURB

Use DND to temporarily stop calls from coming to your extension.

Note: If your phone is set for Call Forwarding-No Answer or Busy (such as to voice mail), only calls from other extensions will be blocked. External calls will still ring through to your extension before being forwarded to voice mail. Permanent call forwarding is determined through system programming.

▶ To turn DND on

1. Pick up the handset or press the **ON/OFF** key.
2. Do one of the following

To turn DND on ...	Do ...
For your extension	Enter the DND Set code (<u>default = 720</u>).
For another extension	<ol style="list-style-type: none"> a. Enter the DND Set by Other Phone code (<u>default = 740</u>). b. Dial the extension number.

3. Replace the handset or press the **ON/OFF** key.

▶ To cancel DND

1. Pick up the handset or press the **ON/OFF** key.

2. Do one of the following

To cancel DND . . .	Do . . .
For your extension	Enter the Cancel DND code (default = 720).
For another extension	a. Enter the Cancel DND Set by Other Phone code (default = 750). b. Dial the extension number.

3. Replace the handset or press the **ON/OFF** key.

6. USING ADDITIONAL FEATURES

The ICX provides a variety of additional features that you can use in your daily work:

- MIC or MIC Key (page 55)
- Off-Hook Monitor (page 56)
- Handsfree Answerback and Operation (page 56)
- Voice Recognition (page 56)
- Flash Feature (page 57)
- Conference Calls (page 57)
- Background Music (page 58)
- Timed Reminders (page 58)
- Caller ID (page 59)
- Waking Class of Service (62)

USING THE MIC KEY

You can use the **MIC** key on your phone or an FF key assigned as a MIC key to mute the handset or microphone so that the party on the other end cannot hear you. (The MIC indicator flashes when using handset mute and goes off when the microphone is muted.)

Note: To use handset mute, you must assign an FF key as a Mute key.

► To block outgoing audio using the MIC key

1. Pick up the handset or press the **ON/OFF** key.
2. Dial the desired number.
3. To mute your conversation:
 - Using the handset mute, press the MIC FF key.
 - Using the microphone mute, press the **MIC** key.
4. To turn the mute function off:
 - Using the handset mute, press the MIC FF key.
 - Using the microphone mute, press the **MIC** key.

USING OFF-HOOK MONITOR

Off-Hook Monitor allows you to play a called or calling party's voice through the speaker on your phone, even if you are using the handset. This allows a third party to hear both sides of a conversation.

Note: Off-Hook Monitor does not activate your phone's microphone. The party at the other end will hear only audio transmitted through your handset.

▶ To put a call on speaker

1. During a handset call, press the **ON/OFF** key. (The other party is audible through the speaker, but the handset is mute.)
2. Press the **ON/OFF** key again, to take the caller back off speaker and continue the call through the handset.

USING HANDSFREE ANSWERBACK AND OPERATION

You can answer intercom calls as well as access all available system features without lifting the handset.

Note: To answer intercom calls without lifting the handset, the system must be programmed for Voice Calling. (For more information, see Using Voice Recognition below.)

▶ To answer calls without lifting the handset

1. When the intercom call arrives, make sure the **MIC LED** is on. (If it is not lit, press the **MIC** key to turn it on.)
2. Speak into the microphone to answer the call.

▶ To use system features without lifting the handset

1. Press the **ON/OFF** key.

USING VOICE RECOGNITION

With the installation of additional hardware, you can use verbal commands to dial extensions, speed dial numbers, and access various phone features.

Note: This feature requires system programming and addition hardware (VB-44224 Telephone and VM-44101 Voice Recognition Adaptor). For more information, see your system administrator or ICX dealer.

USING THE FLASH FEATURE

You can send a signal to your phone to release an outside line by pressing the **FL/R** key or the **PROG** key. Once you press either key, your phone will either reseed the same outside line or switch to extension dial tone status.

Note: This feature requires system programming. For more information, see your system administrator or ICX dealer.

MAKING CONFERENCE CALLS

You can use your phone to create conference calls that include up to three parties. (With the installation of an optional 8-party conference card, you can include up to eight parties.)

Notes:

- 3-party conferencing supports the following combinations of parties:
 - 3 extensions
 - 2 extensions and 1 outside line
 - 1 extension and 2 outside lines
- 8-party conferencing supports the following combinations of parties:
 - 8 extensions
 - 7 extensions and 1 outside line

► To establish a three-party conference call

1. While on a call, press the **HOLD** key or the outside line key you are using.
2. Access an outside line or dial the number of the extension you want to add to the call.
3. If you accessed an outside line, dial the number of the party you want to add to the call. Otherwise, proceed to step 4.
4. Press the **CONF** key when your call is answered. (You are connected to the called party.)
5. To add another party repeat steps 1-4.

▶ To establish an eight-party conference call

1. While on a call, press the **HOLD** key or the outside line key you are using.
2. Enter the 8-party Conference Set code (default = 788).
3. Press the **HOLD** key.
4. Access an outside line or dial the number of the extension you want to add to the call.
5. If you accessed an outside line, dial the number of the party you want to add to the call. Otherwise proceed to step 6.
6. Press the **CONF** key. (You are connected to the called party.)
7. To add another party, repeat steps 3-6.

▶ To drop out of a conference call

Note: If the originating party hangs up, all conference calls will be terminated.

1. Hang up or press the **FL/R** key or the **ON/OFF** key.

CONTROLLING BACKGROUND MUSIC

If your system is set up with a music source, you can play music over the speaker of your phone. (If Music On Hold is provided with your system, callers will automatically hear music when you place them on hold.)

▶ To turn background music on or off

1. Pick up the handset or press the **ON/OFF** key.
2. Enter the Background Music code (default = *30).
3. Replace the handset or press the **ON/OFF** key.

Note: On a large-display phone, you can turn background music on or off by pressing the **BGM** soft key while in the Function System menu.

USING TIMED REMINDERS

You can program your phone to act as an alarm clock and alert you at a designated time with an audible tone.

▶ To set a timed reminder (reminder alarm)

1. Pick up the handset or press the **ON/OFF** key.
2. Enter the Timed Reminder Set code (default = *31).
3. Enter the time, in 24 hour format, you want the timed reminder (alarm) to sound. (For example, 0100 = 1:00 am, 1200 = 1:00 pm)
4. Replace the handset or press the **ON/OFF** key.

▶ To cancel a timed reminder

1. Pick up the handset or press the **ON/OFF** key.
2. Enter the Cancel Timed Reminder code (default = *39).
3. Replace the handset or press the **ON/OFF** key.

USING CALLER ID

When the Caller ID feature is activated, your telephone displays Caller ID information as incoming calls ring at your extension. You also have access to previous call information via the Caller ID Call Log feature.

Caller ID Call Log

Note: This feature requires system programming or a specific DBS configuration, and may not be available. For information, see your system administrator or ICX dealer.

The Call Log keeps a record of Caller ID calls that ring your phone. You can access this log by assigning an FF key to flash when there is a new entry in the log. When you press the key to access the log, the LED turns off.

Each Call Log entry includes the following call information:

- Calling number
- Calling name (if provided)
- Time and date
- How the call was answered
- How the call was routed.

Call Log Operation for a Small-display Phones

You can view both the calling number information as well as the detailed information on each entry. In addition, you can outdial the displayed number or store the displayed number in a personal speed dial bin.

► To view, dial or store the call log entry for a small-display

1. Go off-hook or press **ON/OFF**.
2. Dial the Call Log feature code (default=CONF 96).

The following displays:

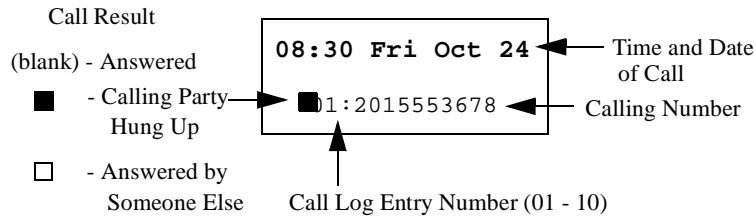

3. Press # to move forward in the call log and press * to move back in the call log.
4. To outdial the displayed call log number,

press the left EXEC key to outdial a leading digit (usually 1) followed by the displayed number

or

press the right EXEC key to outdial the displayed number.

5. To store the displayed call log number in a personal speed dial bin,
- press PROG, the speed dial bin number and press the left EXEC key to store a leading digit (usually 1) followed by the displayed number
- or
- press PROG, the speed dial bin number and press the right EXEC key to store the displayed number

6. To exit the Call Log, go on hook or press **ON/OFF**.

Call Log Format for the Large-Display Phone

You can view both the calling number information as well as the detailed information on each entry. In addition, you can outdial the displayed number or store the displayed number in a personal speed dial bin.

► To view, dial or store call log entry for a large-display phone

1. Go off-hook or press **ON/OFF**.
2. Dial the Call Log feature code (default=CONF 96).

The following displays:⋮

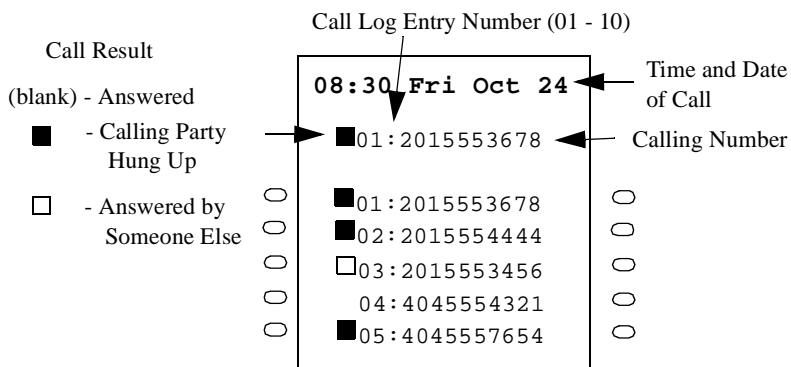

3. Press **#** to move forward in the call log and press ***** to move back in the call log.
4. Press **NEXT** to view the next 5 calls and **PREV** to view the previous 5 calls.
5. To outdial the displayed call log number,
 - press the left soft key to outdial a leading digit (usually 1) followed by the displayed number
 - or
 - press the right soft key to outdial the displayed number.
6. To store the displayed call log number in a personal speed dial bin,
 - press **PROG**, the speed dial bin number and press the left soft key to store a leading digit (usually 1) followed by the displayed number

or

press **PROG**, the speed dial bin number and press the right soft key to store the displayed number

press the right **EXEC** key to outdial the displayed number.

7. To exit the Call Log, go on hook or press **ON/OFF**.

WALKING CLASS OF SERVICE

Walking Class of Service (COS) allows you to use your own calling privileges at another phone. For example, you may be allowed to make long-distance calls from your phone, but a phone in your company's warehouse may be restricted from long-distance calls.

To make long-distance calls from the restricted phone, you can go to that phone and enter a Walking COS code before dialling the number.

Notes:

- Before using this feature, a Walking Class of Service must be assigned for your phone by the system administrator of ICX dealer.
- The same Walking Class of Service code may be used by more than one extension.

► To use a Walking COS code

1. From an extension other than your own, pick up the handset or press the **ON/OFF** key.
2. Enter the walking class of service access code (default=**87**).
3. Dial *your* extension number.
4. Enter your Walking COS code.
5. Press the **#** key.
6. Access an outside line.
7. Dial the phone number.

The Walking COS will remain in effect until you hang up.

Appendix A. Dial Code List

This appendix summarizes the most commonly used dial codes. Additional features may be programmed as described in Section 700 - *Feature Operation*.

The table includes the following information:

- Function - Lists the name of the function or feature
- Fixed Dial Code - This dial code is hard-coded and cannot be changed.
- Flexible Dial Code - This dial code can be used as a default or it can be customized.
- Customized Dial Code - This dial code is customized by the system programmer.

Notes:

- Fixed dial codes and flexible dial codes require different procedures. Be sure to determine which dial codes your system uses to ensure the use of the appropriate procedure for a specific task.
- Default dial codes use the same procedures as flexible dial codes.

Table 6. Dial Code Table

Function	Fixed Dial Code (REDIAL +)	Flexible Dial Code	Customized Dial Code
Account Codes	*57	8#	
Alarm Set	*22	*31	
Alarm Clear	*23	*39	
Answer Key	*69		
Background Music Set/ Cancel	*24	*30	
BLF/DSS Outgoing	9 + extension number		
BLF/DSS Immediate Ring	81 + extension number		
BLF Delayed Ring	82 + extension number		
BLF/DSS No Ring	83 + extension number		
Busy Override Set	*53		
Call Forward (All Calls): Set	70 + extension number	721 + extension number	
Call Forward (All Calls): Cancel	*09	731 + extension number	
Call Forward (All Calls): Set from another ext.	*10	741	

Function	Fixed Dial Code (REDIAL +)	Flexible Dial Code	Customized Dial Code
Call Forward (All Calls): Cancel from another ext.	*11	751	
Call Forward (All/Busy/No Answer/DND): Clear	*21	7**	
Call Forward (Busy): Set	72 + extension number	722 + extension number	
Call Forward (Busy): Cancel	*15	732 + extension number	
Call Forward (Busy): Set from another ext.	*16	742	
Call Forward (Busy): Cancel from an other ext.	*17	752	
Call Forward (No Answer): Set	71 + extension number	723 + extension number	
Call Forward (No Answer): Cancel	*12	733 + extension number	
Call Forward (No Answer): Set from another ext.	*13	743 + extension number	
Call Forward (No Answer): Cancel from another ext.	*14	753 + extension number	
Call Park Hold/Answer	*63		
Call Park Hold	*64	771	
Call Park Answer (Own Ext.)	*65	772	
Call Park Answer (Other Ext.)	*66	773	
Call Park Transfer	*67	774	
Call Pickup Group (All Calls)	*31	701	
Call Pickup Group (CO Calls only)	*32	702	
Call Pickup Group (designated)	*33 + (call pickup group 1-99)	703	
Call Pickup - Direct Trunk	*34	*0	
Callback at Busy Tone	*49	N/A	N/A
Camp-on at BusyTone	*50	N/A	N/A
Conference Key	*36		
Day1/Night Toggle	*25	760	
Day2	*26	761	
Direct Call Pick-Up	73 + extension number	704	
DND: Set/Cancel	*18	720	

Function	Fixed Dial Code (REDIAL +)	Flexible Dial Code	Customized Dial Code
Extension Call	Extension number	N/A	N/A
Extension Directory Name Assignment	*41		
Flash/Recall Key	*39		
Floating Hold: Answer	*04	*9	
Headset Mode	*35		
Meet-Me Answer	*30	##	
Message Waiting (Callback): Cancel	*07	*5	
Message Waiting (Callback)	*08	*6	
Message Waiting Set at Busy Tone	*51		
Message Waiting Set at Ringback Tone	*55		
Night 1	*27	762	
Night 2 (for Built-In Voice Mail messages)	*28	763	
Off-Hook Voice Announce	*70		
Paging	*29 + (page group number)	# + (zone number)	
Program Key	*38		
PSD Name Assignment	*40	N/A	
Release Key	*68		
Speed Dial Send	*01	80	
Split Key	*71		
System Speed Dial Name Assignment	*42		
Timed Reminder (alarm) - Set	*22	*31	
Timed Reminder (alarm) - Cancel	*23	*39	
Tone/Voice Switch	*54	N/A	
Transfer Key	*37		
Variable Mode	*61		
Voice Mail Transfer Key 1	74 + Extension Number		
Voice Mail Transfer Key 2	75 + Extension Number		
Walking TRS Key	*72		

Appendix B. Customized PSD Bin Numbers

This appendix contains a table for documenting the Personal Speed Dial (PSD) numbers that you assign to PSD bins on non-display phones. When making changes to PSD numbers, be sure to record the change in this following table.

Table 7. Customized PSD numbers (assigned to PSD bins)

PSD Bin Number	PSD Number	PSD Name
80		
81		
82		
83		
84		
85		
86		
87		
88		
89		
90		
91		
92		
93		
94		
95		
96		
97		
98		
99		

Numerics3-party conference call **57**8-party conference call **58****A**Accessing an outside line **31** using an FF key **31** using an outside line access code **31**

Account Codes

 using **32**

Account codes

entering non-verified codes

 before making a call **32** during a call **33** entering verified ID codes **33** Non-verified **32** Verified ID codes **33**

Additional Features

 using **55**

Adjusting

 display **18** display contrast **19** sound **18**

Alarms

 canceling timed/reminder **59, 60, 61, 62** setting timed/reminder **59** timed/reminder **58**

Announcement to busy extension

 answering **48** transferring calls with **48**

Answering

 announcement to busy extension **48** off-hook voice announcement **48**

Answering a message waiting/callback

 request **52**Answering calls **38** a call ringing a phone outside your
 extension group **38**

a call ringing a phone within your

 extension group **38** a call ringing someone else's phone **38** an external call ringing a phone within
 your extension group **38** handsfree **56**Answering page from any extension **47**

Assigning

feature code

 to one-touch key **21**

PSD names to PSD number

 large-display phone **27**

PSD names to PSD numbers

 small-display phone **26**

PSD numbers

 to one-touch or soft keys **23**

SSD number

 to one-touch key **21**Assigning names to PSD numbers **26** large-display example **29** small-display example **28**Assigning PSD names **26**Assigning PSD numbers **22**Assigning SSD Numbers **25**Auto-Redial **33****B**Background music **58** turning on/off **58**

Blocking outgoing audio

 mute key **55**Breaking into an outside call **49**

Broker's hold

 Toggling between two calls **39**Busy outside line **32**Busy override, using **49****C**

Call forward

 all incoming calls **49**

all incoming calls to a busy extension

- 49**
- Call Forwarding
 - canceling **51**
 - using **49**
- Call hold
 - broker's hold **39**
 - floating hold key **39**
 - holding calls **39**
 - using broker's hold **39**
 - retrieving **39**
 - from a different extension than the one that placed call on hold **39**
 - from broker's hold **39**
 - from extension that placed call on hold **39**
 - using **38**
- Call transfer
 - to a busy extension **41**
- Call Waiting
 - answering a call waiting signal **51**
 - automatically camping on a line **51**
 - manually camping on a line **51**
 - using **51**
- Callback messages **52**
 - responding to a callback request **52**
 - sending a callback request **52**
- Callback request
 - busy outside line **32**
- Calling Forwarding
 - setting up **49**
- Calling other extensions **45**
 - entering extension number **45**
 - using soft key
 - large-display phone **46**
 - using soft keys
 - small-display phone **45**
- Camp-on
 - answering a call waiting signal **51**
 - using **51**
 - using automatic camp-on **51**
 - using manual camp-on **51**
- Canceling
 - alarms - timed/reminder **59, 60, 61, 62**
 - automatic redial **34**
 - call forwarding **51**
 - DND **51**
- Chaining/linking
 - SSD numbers
 - to PSD bin **25**
 - using assigned PSD key **26**
- Chaining/linking SSD numbers **25**
- Changing modes (display)
 - large-display phone **15**
 - small-display phone
 - Displaying a directory
 - small-display phone **11**
- Checking speed dial numbers **36**
 - entering speed dial bin number **37**
 - using soft keys
 - large-display phone **36**
 - small-display phone **36**
- Communicating within your office **45**
- Conference calls
 - 3-party **57**
 - 8-party **57**
 - dropping out of **58**
 - establishing a 3-party call **57**
 - establishing an 8-party call **58**
 - making **57**
- D**
- Deleting
 - PSD names assigned to PSD numbers **30**
 - PSD numbers
 - assigned to one-touch or soft keys **24**

-
- Deleting names assigned to PSD numbers **30**
 - Deleting PSD Names **26**
 - Deleting PSD Numbers **22**
 - Dial code list **63, 66**
 - Dialing speed dial numbers **34**
 - entering speed dial bin number **35**
 - using one-touch keys **34**
 - using soft keys
 - large-display phone **35**
 - small-display phone **34**
 - Direct outside line key **31**
 - Display
 - contrast adjustment **19**
 - large **13**
 - small **9**
 - Display Information
 - large-display phone **16**
 - small-display phone **11**
 - Displaying a directory
 - large-display phone **15**
 - Do-Not-Distrub (DND)
 - canceling **53**
 - setting up **53**
 - Do-Not-Disturb
 - canceling **51**
 - Do-not-disturb (DND)
 - using **53**
 - E**
 - Entering speed dial numbers
 - to check SSD entries **37**
 - to dial speed dial numbers **35**
 - F**
 - FF key
 - accessing an outside line **31**
 - direct outside line **31**
 - feature codes **63, 66**
 - Flash feature **57**
 - Floating hold key **39**
 - H**
 - Handling incoming calls **38**
 - Handsfree answerback/operation
 - answering calls **56**
 - using **56**
 - using system features **56**
 - I**
 - In-office communications **45**
 - Internal
 - communications **45**
 - tone/voice switching **46**
 - L**
 - Large-display phone **13**
 - Linking/chaining
 - SSD numbers
 - to PSD bin **25**
 - using assigned PSD key **26**
 - Linking/chaining SSD numbers **25**
 - M**
 - Meet-Me Answer **47**
 - Message waiting **52**
 - responding to a callback request **52**
 - sending a callback request **52**
 - Monitor, off-hook **56**
 - Music
 - background **58**
 - Mute key
 - blocking out going audio **55**
 - using **55**
 - N**
 - Non-verified account code
 - entering before making a call **32**
 - entering during a call **33**
 - Non-verified account codes **32**
-

Q

- Off-hook monitor
 - putting a call on speaker **56**
 - using **56**
- Off-hook voice announcement
 - answering **48**
 - transferring calls with **48**
- One-touch keys
 - assigning a feature code **21**
 - assigning an SSD number **21**
 - checking **21**
 - programming for outside phone number **20**
 - setting up **20**
- Outside call
 - breaking into **49**
- Outside calls
 - placing **31**
- Outside line access code **31**
- Outside line key, direct **31**

P

- Paging
 - answering from any extension **47**
 - meet-me answer **47**
 - using **47**
- Personal Speed Dial (PSD)
 - assigning PSD names to PSD number
 - large-display phone **27**
 - small-display phone **26**
 - assigning PSD numbers to one-touch keys **23**
 - deleting PSD names assigned to PSD number **30**
 - deleting PSD numbers assigned to one-touch keys **24**
- Personal Speed Dial (PSD) keys
 - that link multiple speed dial numbers

26

- Personal Speed Dialing (PSD)
 - assigning names **26**
 - assigning numbers **22**
 - deleting names **26**
 - deleting numbers **22**
- Placing outside calls **31**
 - accessing an outside line **31**

R

- Redial
 - Auto **33**
- Redialing
 - automatically redialing a busy number **33**
 - canceling automatic redial **34**
 - last outside number dialed **33**
- Redialing outside numbers **33**
- Reminder alarm **58**
 - canceling **59, 60, 61, 62**
 - setting **59**
- Retrieving calls on hold **39**

S

- Sending a message waiting/callback request **52**
- Setting up
 - 3-party conference call **57**
 - 8-party conference call **58**
 - alarms - timed/reminder **59**
 - call forwarding **49**
 - forwarding all incoming calls **49**
 - forwarding all incoming calls that ring busy extension **49**
 - DND **53**
 - one-touch keys **20**
 - speed dialing **22**
 - telephone **18**
- Small-display phone **9**

-
- Speaker phone
 - putting a call on **56**
 - Speed dial numbers
 - dialing **34**
 - entering speed dial bin number **35**
 - using one-touch keys **34**
 - using soft keys
 - large-display phone **35**
 - small-display phone **34**
 - Speed dialing
 - checking numbers **36**
 - entering speed dial numbers **37**
 - using soft keys on large-display phone **36**
 - using soft keys on small-display phone **36**
 - setting up **22**
 - Supervised call transfer **40**
 - to another extension or outside number **40**
 - Switching from tone to voice calling **46**
 - System Speed Dial (SSD)
 - chaining/linking
 - to PSD bin **25**
 - using assigned PSD key **26**
 - chaining/linking numbers **25**
 - System Speed Dial (SSD) Numbers
 - Assigning **25**
- I**
- Telephone
 - large-display **13**
 - parts **7**
 - setting up **18**
 - small-display **9**
 - Timed reminder
 - canceling **59, 60, 61, 62**
 - setting **59**
 - Timed reminders **58**
 - Tone calling **46**
 - Transferring calls
 - supervised transfers **40**
 - to a busy extension **41**
 - unsupervised transfers **40**
 - Transferring
 - with announcement to busy extension **48**
 - with off-hook voice announce **48**
 - Transferring calls **40**
- U**
- Understanding your phone **7**
 - Unsupervised call transfer **40**
 - to another extension or outside number **40**
- V**
- Verbal commands **56**
 - Verified ID codes **33**
 - Voice calling **46**
 - Voice recognition **56**
 - Volume
 - handset **18**
 - receiver **18**
 - ringer **18**
 - speaker **18**
-

Panasonic®

©Copyright 1998